

1. Ścianka 10,714 m - 1,43 m
2. Ścianka 10,714 m - 1,43 m
3. Ścianka 10,714 m - 1,43 m
4. Ścianka 10,714 m - 1,43 m
5. Ścianka 10,714 m - 1,43 m
6. Ścianka 10,714 m - 1,43 m
7. Ścianka 10,714 m - 1,43 m
8. Ścianka 10,714 m - 1,43 m
9. Ścianka 10,714 m - 1,43 m
10. Ścianka 10,714 m - 1,43 m
11. Ścianka 10,714 m - 1,43 m

KONSTRUKCJA OBIEKTU
 Branża: Budownictwo
 Nazwa obiektu: ...
 Inwestor: ...
 Projektant: ...

PROJEKT STÓP FUNDAMENTOWYCH
 SKALA 1:25

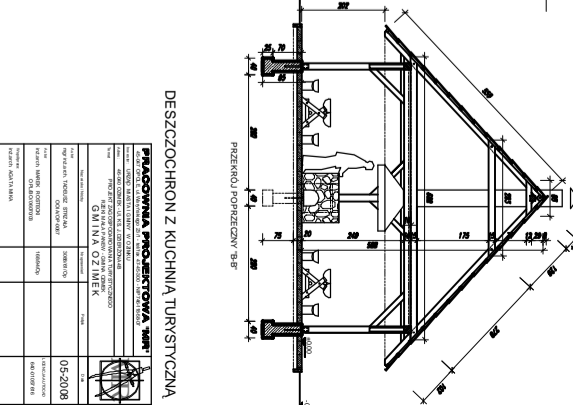
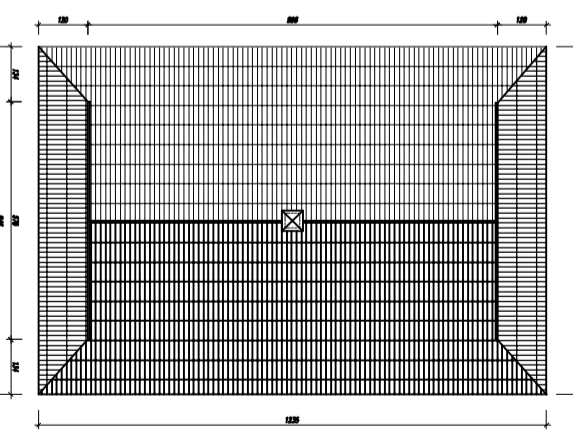
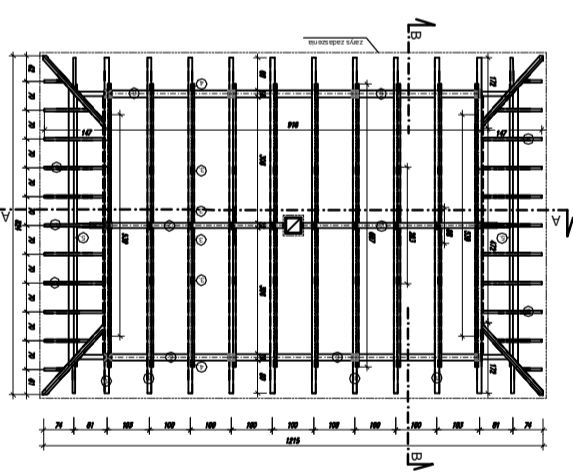
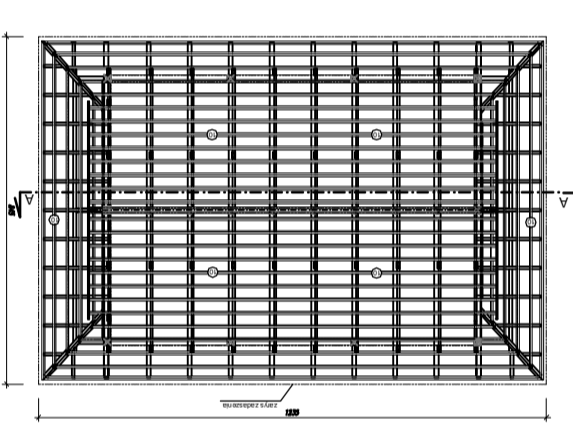
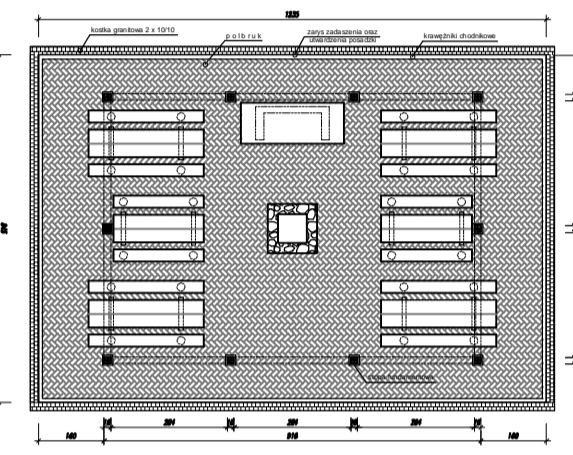
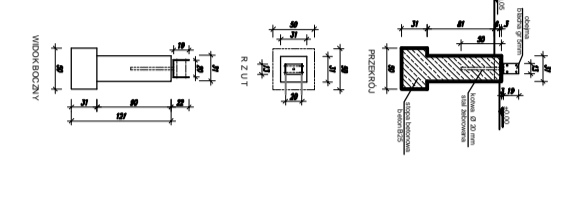
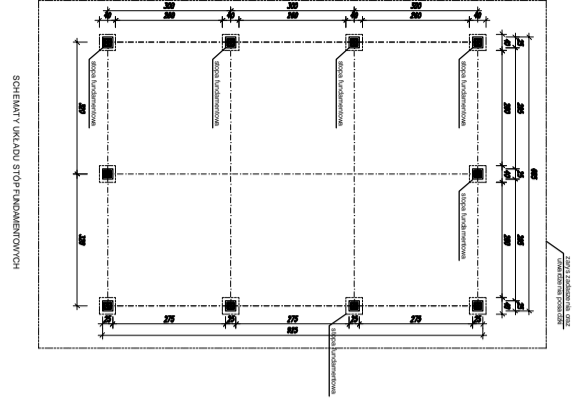

PROJEKT BUDOWLANY DESZCZOCHRONU
 SKALA 1:50

PAŁACOWA PROJEKTOWA SPA	
Biuro Projektowe	
ul. ...	
09-5009	
1/50 10	